

MES0512MH DC-to-DC Converter Modules

Special Features

- Small multi-purpose power supply
- Wide Input Range
- Isolated output
- Short circuit protection
- Over voltage protection
- Thermal shutdown



Electrical Characteristics

Characteristics		Condition	Min.	Typ.	Max.	Unit
DC Input	Input Voltage Range	$I_{o1}=1.6A, I_{o2}=150mA$	120	311	375	V
Output	Output Voltage(DC)	$V_i=311V, I_{o1}=0\sim 1.6A$	4.65	5.00	5.35	V
	Output Voltage(AC)	$V_i=311V, I_{o2}=0\sim 150mA$	10.5	12.0	14.0	
	Output Current	$V_i=311V, V_{o1}=5.0Vdc$	-	-	1.6	A
		$V_i=311V, V_{o2}=12.0Vac$	-	-	150	mA
	Line Regulation	$V_i=120\sim 375V, I_{o1}=1.6A$	-	-	0.25	V
	Load Regulation	$V_i=311V, I_{o1}=0\sim 1.6A$	-	-	0.25	V
	Ripple Voltage	$V_i=311V, I_{o1}=1.6A$	-	-	0.20	Vp-p
	Efficiency	$V_i=311V, I_{o1}=1.6A, I_{o2}=150mA$	-	72	-	%
Power Consumption	Full Load	$V_i=311V, I_{o1}=1.6A, I_{o2}=150mA$	11.7	13.0	14.3	W
Ambient Temperature	Operating Range	$V_i=311V, I_{o1}=1.6A, I_{o2}=150mA$	-10	-	70	°C
	Storage Range		-20	-	105	°C

Notes

(1) For cases where the conformance to various safety spec is required, input voltage range will be 120V ~ 375V

■ **Block Diagram**

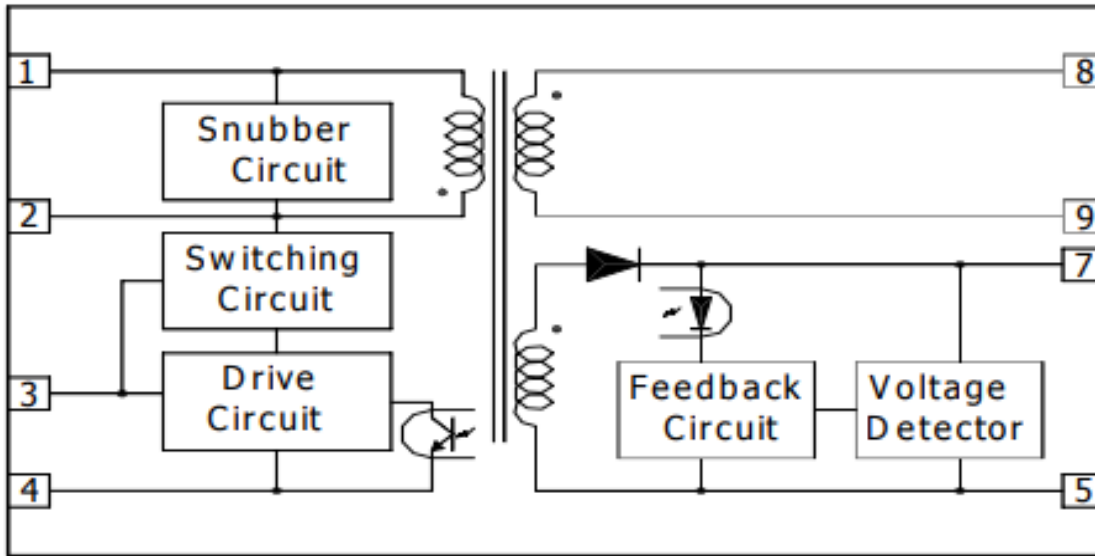

■ **Dimension**

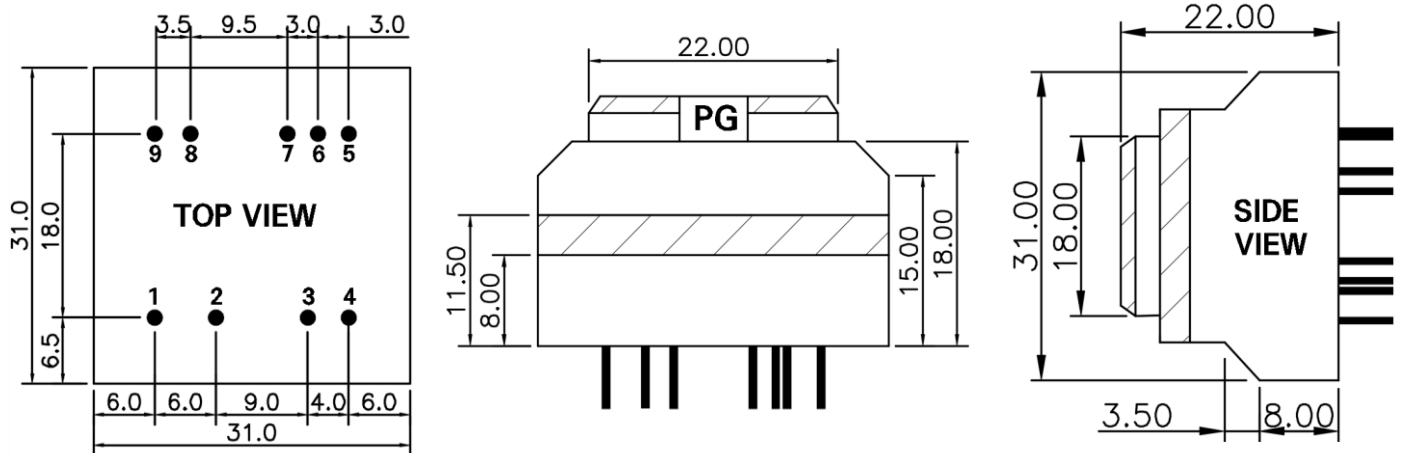

Pin No.	Description	Pin No.	Description
1	DC INPUT (+)	5	DC OUTPUT GND
2	DRAIN	6	NC
3	NC	7	DC OUTPUT(5.0V)
4	DC INPUT (-)	8	AC OUTPUT(12.0V)
		9	AC OUTPUT GND

Notes

- 1.Dimension in mm
- 2. PIN : Ø 0.7

■ Application Circuit

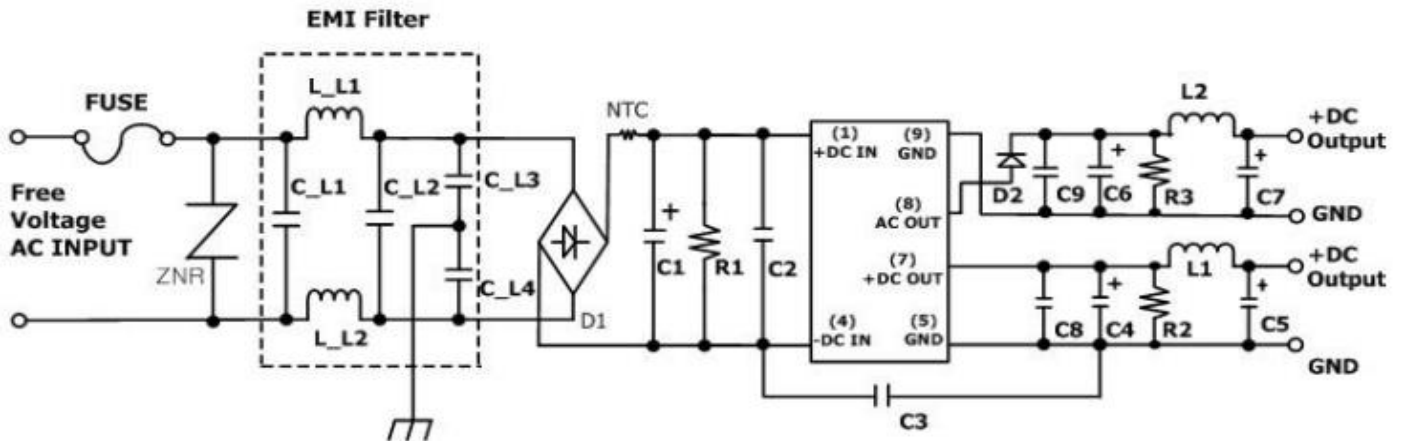

FUSE	Fuse	Please make sure to use quick acting fuse 1A
C1	Capacitor for input voltage smoothing	Capacitance : 10 μ F ~ 820 μ F, Rated Voltage : 400V or higher Ripple current is 0.13Arms above
C2	For noise terminal voltage reduction	Capacitance : 0.1 μ F ~ 0.22 μ F, Rated Voltage : 400V or higher Film capacitor or ceramic capacitor Reduce the noise terminal voltage The constant value should be evaluated in the set
C3	Capacitor for Safety	Capacitance : 1nF ~ 4.7nF, Rated Voltage : 400v or higher
C4, C5, C6, C7	Capacitor for output voltage smoothing	Capacitance : 470 μ F~1000 μ F, Rated voltage : 25V or higher ESD is 0.4 Ω max. Ripple current is 0.25Arms above. Output noise voltage is influenced. Please evaluate it in the actual set.
C8, C9	Bypass Capacitor for high frequency noise	Capacitance : 10nF~100nF, Rated voltage : 50V or higher Film capacitor or ceramic capacitor. Reduce the high frequency noise terminal output.
L1	Choke Coil	L : 4.7 μ H~10 μ H, Allowable current : 800mA or higher Please use the one that is hard to be magnetic saturated even in the high temperature.
L2	Choke Coil	L : 10 μ H~33 μ H, Allowable current : 300mA or higher Please use the one that is hard to be magnetic saturated even in the high temperature.
D1	Rectifier Diode	In the absolute maximum ratings, the reverse peak voltage should be 500V or higher, the average rectifying current should be 1A or higher, and the peak surge current should be 10A or higher. (Full-wave rectifier can be used in out part.)
D2	Fast Recovery Diode	In the absolute maximum ratings, the reverse peak voltage should be 200V or higher, the average rectifying current should be 1A or higher, and the peak surge current should be 10A or higher. (Full-wave rectifier can be used in out part.)
R1	Discharge Resistor	500k Ω or higher, 1W or higher
R2, R3	Dummy Resistor	1k Ω , 0.5W

■ Packing Specification

1. Inner Box

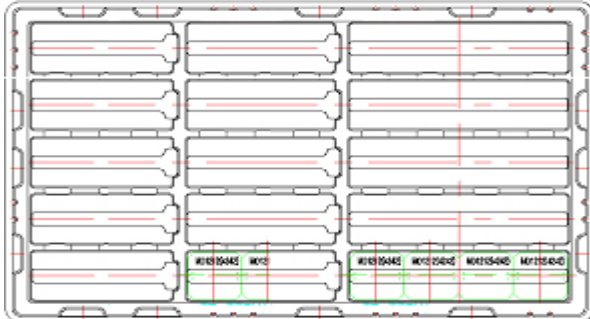

Matter	PET
Quantity	65 pcs (5 X 13)

2. Output Box

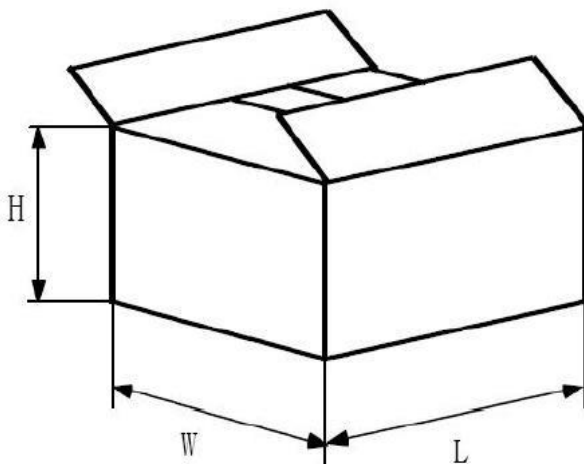

L	460
W	390
H	225
Quantity	390EA
Marking	1. Maker 2. Part Number 3. Quantity

* Unit : mm

POWERGEN Co., Ltd.

67-13, Shinchon-dong, Changwon si, Gyeongnam, S.Korea, 642-370

TEL : + 82 55 275 7801~4

FAX + : 82 55 275 2522

Homepage : www.pwrg.co.kr

Online shop : www.pwrgmall.co.kr

This semiconductor technical data is believed to be accurate and reliable, however POWERGEN does not assume any responsibility arising out of the application or use of any product or circuit described herein; neither does it convey any license under its patent rights nor the rights of others.

POWERGEN reserves the right at anytime without notice to change said circuitry and specifications.